

# Precision

---

## Tufting Components Inc.

### Air Mender & Parts Catalog



**P.O. Box 710 \* 170 Jackson Lake Road \* Chatsworth, GA 30705**

**Phone: 706-695-6593**

**[www.ptuft.com](http://www.ptuft.com)**

September 2018



In this manual, you will find information in regards to Precision's line of Air Menders. This manual is designed to assist you in the operation and ordering of parts for all Precision Air Menders. Due to continual improvements on the Precision Air Mender, it is possible that the construction of your air mender may vary slightly from the diagrams in this manual. Your specific mender may have been customized for your specific need.

When ordering parts, please include the following:

1. Precision Part #
2. Precision Description
3. Size (If Specified)
4. Quantity

Please, take the time to review our air mender catalogue for your mending needs.



The Precision Air Mender is fully operated by an Ingersol Rand Air motor. Precision currently stocks 550 RPM, 900 RPM and 1500 RPM motors. The Air Mender performs at its best when under constant air pressure of 90 lbs. pressure. Precision's Air Menders' currently operate in all areas of Carpet production including but not limited to residential, commercial and grass turf applications. Precision Air Menders are available for the following:

Short Nap Work (1/8" – 1/2" Pile Heights)

Level Nap Work (1/4" - 1" Pile Heights)

Shag (1/2"– 2½" Pile Heights)

Super Shag (2 1/2"- 4" Pile Heights)

Hi-Lo Nap Electronically Operated for varying patterns

Tri-Nap Electronically Operated for varying patterns

#### Auxiliary Equipment Available:

- Trolley with Yarn Holder
- Balancer
- Filter, Regulator, Lubricator





# Precision Standard Mender



# Standard Mender

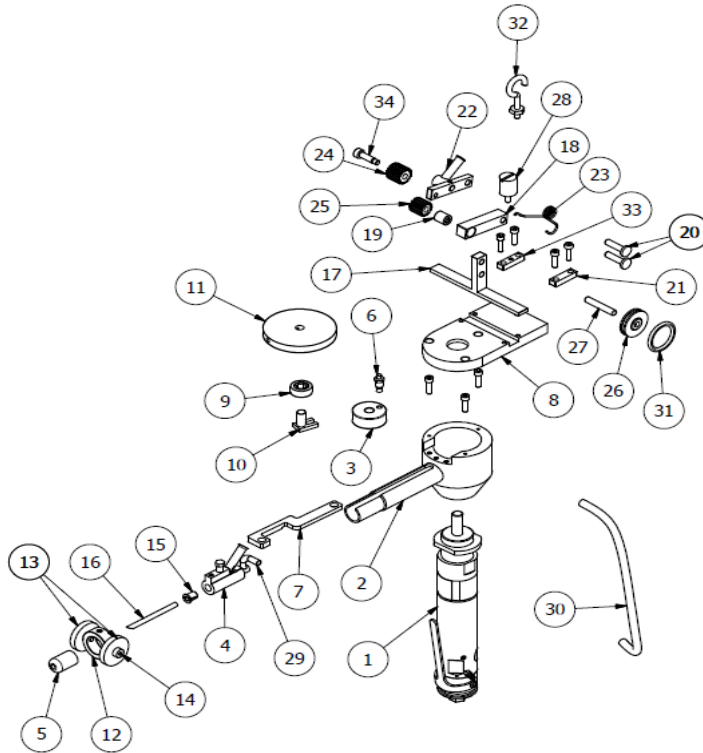

<u>Item</u>	<u>Qty</u>	<u>Description</u>	<u>PTC Part #</u>
1	1	3CS013M5492 IR 900 RPM Air Motor	18135492
2	1	Housing	P-001
3	1	Drive Cam	P-020
4	1	Needle Carrier	P-024
5	1	Needle Guide Bushing (Specify Size)	P-027
6	1	Connecting Link Stud Shoulder Screw	P-018
7	1	Connecting Link	P-017
8	1	Standard Cover Plate	P-002
9	1	Flange Bearing	P-022
10	1	Drive Fork	P-021
11	1	Drive Disk	P-003

<u>Item</u>	<u>Qty</u>	<u>Description</u>	<u>PTC Part #</u>
12	1	Axle Ring	P-028
13	2	Pressure Foot Roller	P-029
14	2	Pressure Foot Roller (Shoulder Screw)	NA
15	1	Collet (Specify Size)	P-025
16	1	Needle (Specify Size)	P-026
17	1	Standard Slide Bar	P-004
18	1	Feed Roller Support Arm	P-008
19	1	Feed Roller Bearing	P-010
20	2	Pivot Pin	P-009
21	1	Slide Bar Cap	P-005
22	1	Idler Roller Support Arm	P-015
23	1	Tension Spring	P-007
24	1	Idler Roller	Page 17
25	1	Feed Roller	Page 17
26	1	1" Drive Wheel	P-014
26	1	7/8" Drive Wheel (Shag)	P-014S
26	1	1-1/8" Drive Wheel	P-014L
27	1	Feed Roller Axle	P-032
28	1	Slide Bar Thumb Screw	P-006
29	1	Air Jet	P-023
30	1	Standard Airline	P-034
31	1	"O" Ring	P-016
32	1	Hanging Hook	P-011
33	1	Slide Bar Cap (Tapped for Thumb Screw)	NA
34	1	Idler Roller Shoulder Screw	NA







# Precision Hi-Lo Mender



# Hi-Lo Mender

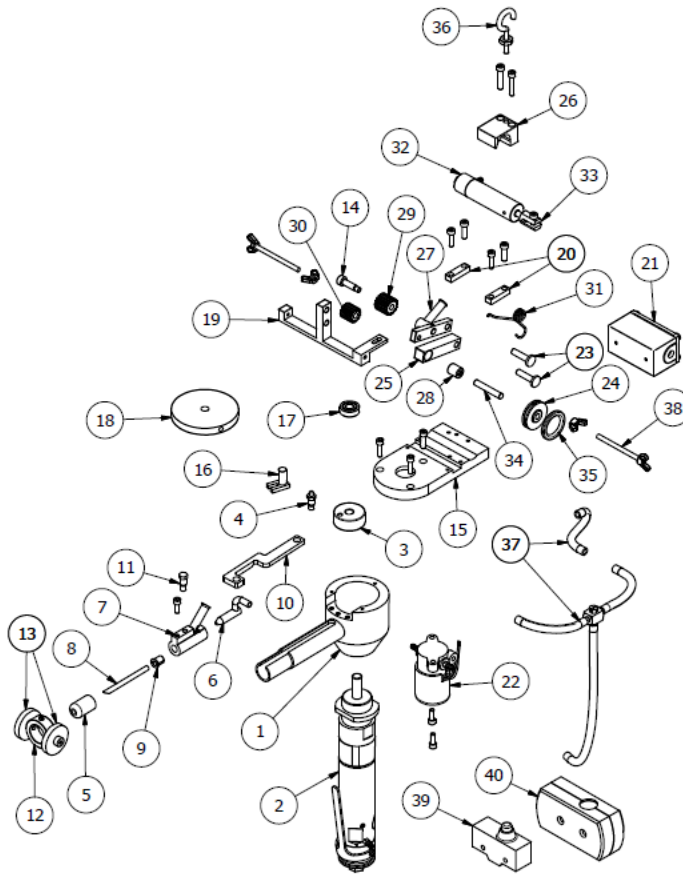

<u>Ite</u> <u>m</u>	<u>Qty</u>	<u>Description</u>	<u>PTC</u> <u>Part #</u>
1	1	Housing	P-001
2	1	3CS013M5492 IR Air Motor	181354 92
3	1	Drive Cam	P-020
4	1	Connecting Link Stud Shoulder Screw	P-018
5	1	Needle Guide Bushing (Specify Size)	P-027
6	1	Air Jet	P-023
7	1	Needle Carrier	P-024
8	1	Needle (Specify Size)	P-026
9	1	Collet (Specify Size)	P-025
10	1	Connecting Link	P-017
11	1	Connecting Link Stud Shoulder Screw	P-019



<u>Item</u>	<u>Qty</u>	<u>Description</u>	<u>PTC Part #</u>
12	1	Axle Ring	P-028
13	2	Pressure Foot Roller	P-029
14	2	Idler Roller Shoulder Screw	
15	1	Cover Plate	P-002
16	1	Drive Fork	P-021
17	1	Flange Bearing	P-022
18	1	Drive Disk	P-003
19	1	Slide Bar (Hi-Lo)	P-004A
20	2	Slide Bar Cap	
21	1	Electrical Box	P-062
22	1	Solenoid Switch	P-056
23	2	Pivot Pin	P-009
24	1	Drive Wheel	
25	1	Feed Roller Support Arm	P-008
26	1	Clamp Block	P-057B
27	1	Idler Roller Support Arm	P-015
28	1	Feed Roller Support Arm Bearing	P-010
29	1	Idler Roller	
30	1	Feed Roller	
31	1	Tension Spring	P-007
32	1	Air Cylinder	P-057
33	1	Clevis	P-059
34	1	Drive Roller Axle	P-032
35	1	"O" Ring	P-016
36	1	Hanging Hook	P-011
37	2	3" & 7" Air Line Assembly	P-033A
38	2	Slide Stop Screw	P-070
39	1	Hi-Lo Switch	P-064S
40	1	Hi-Lo Switch Cover	P-064C





# Precision Super-Shag Mender



# Super Shag Mender

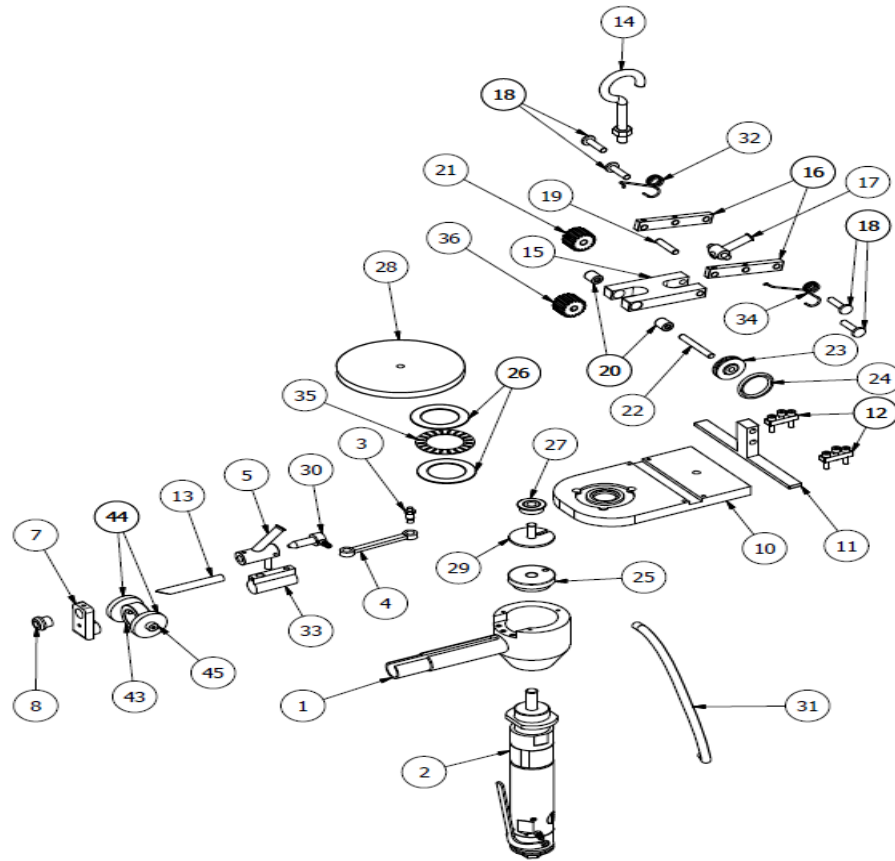

<u>Item</u>	<u>Qty</u>	<u>Description</u>	<u>PTC Part #</u>
1	1	Housing	P-001
2	1	M003 FA01000TBA97039 IR Motor 550 RPM	18197039
3	1	Connecting Link Stud Shoulder Screw	P-018
4	1	Shag Connecting Rod	P-092
5	1	Shag Needle Carrier	P-091
7	1	Shag Needle Bushing Support	P-086
8	1	Shag Needle Bushing	P-087
10	1	Shag Cover Plate	P-084
11	1	Shag Slide Bar	P-082
12	2	Shag Slide Bar Cap	
13	1	Shag Needle (Specify Size)	



<u>Item</u>	<u>Qty</u>	<u>Description</u>	<u>PTC Part #</u>
14	1	Hanging Hook	P-011
15	1	Feed Roller Support Arm	
16	2	Idler Roller Support Arm	
17	1	Idler Roller Yarn Guide	
18	4	Pivot Pin	P-009
19	1	Idler Roller Axle	
20	2	Feed Roller Bearing	P-010
21	1	.750" Idler Roller	
22	1	Feed Roller Axle	
23	1	7/8" Drive Wheel	P-014S
24	1	.875" "O" Ring	P-016
25	1	Shag Drive Cam	P-079
26	2	Thrust Bearing Race	P-089
27	1	Flange Bearing	P-022
28	1	Shag Drive Disk	P-085
29	1	Shag Drive Fork	
30	1	Shag Air Jet	
31	1	Shag Air Line	P-034
32	1	Tension Spring RH	
33	1	Push rod	P-090
34	1	Tension Spring LH	
35	1	Thrust Bearing Race	P-088
36	1	.750" Feed Roller	P-012
43	1	Axle Ring	P-028
44	2	Pressure Foot Roller	P-029
45	2	Pressure Foot Roller Shoulder Screw	



## Stitch Feed Assembly

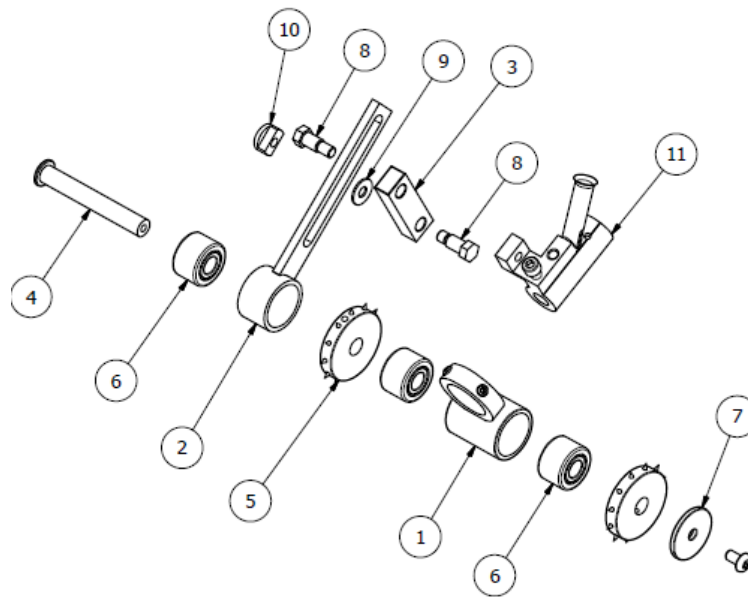

PARTS LIST			
ITEM	QTY	DESCRIPTION	PARTS NUMBER
1	1	Stitch feed axle ring	
2	1	Stitch feed actuator arm	
3	1	Stitch Feed Link	
4	1	Stitch Feed Axle	
5	2	Pressure Foot Pin Roller	
6	3	Stitch feed bearing assembly	
7	1	Stitch feed axle washer	
8	2	SHOULDER SCREW 2	
9	1	Stitch feed link washer	
10	1	Stitch feed link nut	
11	1	NEEDLE CARRIER	





# Mender Gear Set-Up

SHORT NAP

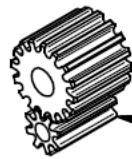

16 TOOTH IDLER P-013L

8 TOOTH FEED P-012S

LEVEL NAP

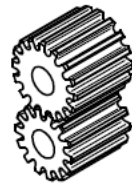

16 TOOTH IDLER P-013L

14 TOOTH FEED 1/2" DIA. P-012L

SHAG

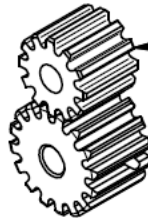

12 TOOTH IDLER P-013

14 OR 16 TOOTH 3/4" FEED P-012

SUPER SHAG

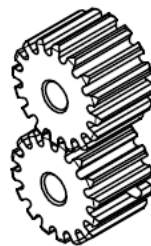

16 TOOTH IDLER P-012

16 TOOTH FEED P-012 W/SET SCREW



## **Air-Mender Standard Adjustments**

### **Air Mender “Needles”**

**Problem** - Replacement of needle resulting from:

- ~ Worn or broken needle
- ~ Desire for different size needle

**Solution:**

- ~ To change needle, first remove pressure foot roller and cap screw
- ~ Loosen clamp screw in pressure foot axle either on top or bottom of axle
- ~ Remove guide bushing
- ~ Remove axle block
- ~ Loosen set screw in needle carrier
- ~ Remove needle
- ~ If a different size needle is desired, also remove needle collet from needle carrier
- ~ To re-assemble, reverse the above procedure with a replacement needle or with a different needle collet, needle, and guide bushing of the new desired size. **Note:** when ordering needles of a different size, be sure you have a collet and needle guide bushing to match.

**Problem** - What size needle for what fabric:

**Solution:**

- ~ The #12 needle (.109 OD x .085 ID) is used on very fine upholstery and other fabric type work.
- ~ The #11 needle (.120 OD x .094 ID) is good for fine work, such as 5/64 gauge where small yarn are used.
- ~ The #10 needle (.134 OD x .106 ID) is used on 1/10 and 1/8 gauge work where a slightly larger yarn might be desired.
- ~ The #9 needle (.148 OD x .118 ID) is supplied standard in air menders unless otherwise specified. It is considered the best general purpose needle, and is good on essentially all types of filament yarn and various other medium size yarns.
- ~ The #8 needle (.165 OD x .135 ID) is used on slightly bulkier yarns such as small acrylics and several of the filaments
- ~ The #7 needle (.180 OD x .150 ID) is desirable for bulky 3-ply yarns in wide gauge operations.



- ~ The #6 needle (.203 OD x .173 ID) is used on large spun yarns, plied acrylics, and on occasions where two or more yarns are used in shag applications.
- ~ The 1/4" needle (.250 OD x .218 ID) is used on exceptionally large, bulky, multiple strand work.

### **Air Mender "Air Nap Control"**

**Problem** - To adjust nap height on level nap machine.

**Solution:**

- ~ Loosen screw in bearing block with set screw
- ~ Move slide bar so that the drive wheel is moved toward the outside of the drive disk to lengthen nap or toward center to shorten nap.

**Problem** - To adjust nap height on Hi/Lo mender

**Solution:**

- ~ For Hi or Lo pile, move adjusting stop screw at either end of slide bar to desired setting.

### **Air Mender "Nap Length Control"**

**Problem** - How to adjust length of nap.

**Solution:**

- ~ Depending on nap desired, selection of the following three gears setups will need to be selected for the desired length needed.
  - ~ Short Nap ( 1/8" - 3/4" ) **Note:** using a 1" drive wheel
  - ~ Level Nap ( 1/4" - 1 1/4" ) **Note:** using a 1" drive wheel
  - ~ Shag Nap ( 1/2" - 2"+ ) **Note:** using a 7/8" drive wheel

**Note:** Gears on located on Idle Roller Support Arm and Feed Roller Support Arm, which is attached to the slide bar.

### **Cleaning and Lubricating**

**Due to the relative newness of small air menders to the tufting industry, we of Precision Loopers, believe that some tips on cleaning and lubrication of the units might be helpful.**

- ~ *It is imperative to keep this mender clean and treat it as a precision tool for a long trouble free life.*



- ~ *The mender should be preceded in the air system by a filter, regulator, lubricator unit.*
  - ~ The filter bowl should never be allowed to become full. Periodic checks and draining of this system should be set up.
  - ~ The Regulator should be set at 90 to 125 PSI for best performance
  - ~ The oiler should be filled with a good grade of SAF 10W motor oil, and set for approximately one drop per hour.

**In the event that your mender becomes overly dirty and begins to drag, slow down and lose efficiency because of sludge and dirt in the system:**

- ~ Check and drain the filter bowl.
- ~ Drain all oil from oiler bowl, and clean and refill with Dow Chemical's Chloerthen Nu or an equivalent thereof and run this through your mender to flush out dirt and sludge. Repeat this procedure 3 or 4 times as needed until mender runs free and up to par.

### **Filter Installation**

Filter must be installed with air flow in direction indicated on the body, upstream from, and as close as possible to regulator, lubricator and mending machine. Filters must be installed so that the bowl hangs down vertically enabling free oil or moisture to fall to the bottom of the bowl.

### **Operation:**

- ~ Solids and tree moisture are automatically removed by the filter.
- ~ Drain the reservoir bowl by opening the screw whenever containment reaches the lower baffle. This is the only attention needed.
- ~ When the filter element requires cleaning, the visual filter guard will look "yellow". Once the indicator has popped up it will remain up regardless of air flow or pressure change. **Note:** Due to rough handling in transit, the visual filter guard indicator may look "yellow" when filter is received. It **MUST** be reset before the filter can be placed in service. Unscrew the dome ring, remove the dome and reset the indicator.



- ~ To clean the filter element, the air pressure must be shut off and the element removed from the unit by:
- ~ Depressing the safety lock on the clamping ring and with a rotating and slight downward force the clamping ring is removed from the head of the unit.
- ~ The bowl is removed from the unit with a downward force.
  
- ~ The retainer baffle assembly is unscrewed from the stem of the unit and the element is removed.
- ~ The filter element shall be washed in the same solution as the transparent bowls. Dry the element by blowing compressed air from inside outward after washing. Replace and reassemble unit.
- ~ Unscrew visual filter guard ring and manually reset the yellow indicator

**Caution:** Do not attempt to remove bowl under pressure

### **Regulator Installation**

- ~ Regulator must be installed with air flow in direction indicated on the body, upstream from, and as close to lubricator, filter and mender as possible. The regulator may be installed in any position for convenient adjustment with no loss in operating characteristics.
- ~ Two gauge ports are provided on the regulator body to permit installation of pressure gauge. Other regulated air pressure lines may be run from either or both of the gauge ports as well as, or instead of, the outlet port. **Note:** Be sure unused port is plugged.
- ~ An air filter should be installed on the high pressure (upstream) side to protect the regulator against foreign matter.



## ***To Adjust Operating Pressure***

- ~ *Regulator adjustment must be made with line pressure valve open. Carefully follow these steps:*
  - ~ Turn regulator adjusting screw counter clockwise to release compression from pressure spring.
  - ~ Turn on air pressure.
  - ~ Adjust operating pressure by turning adjusting screw clockwise until gauge indicates proper pressure.
  - ~ When the required operating pressure has been determined under normal conditions, the adjusting screw lock nut should be tightened.
  - ~ To lower setting, turn adjustment screw counter clockwise until gauge reading is approximately 5 psi less than delivery pressure desired. Then slowly turn adjustment screw clockwise until desired pressure is obtained.

## ***Service***

- ~ If the regulator requires servicing, it can't be completely disassembled in place after line wire pressure has been shut off.
- ~ Occasionally remove the bottom plug and clean out the internal parts. It is not necessary to remove the regulator from the air line to do so.

**Caution:** Do not attempt to disassemble regulator while line is under pressure.

## **Lubricator Installation**

- ~ Lubricator must be installed with air flow in direction indicated on the unit. Location must be upstream from, and as close as possible to the mending gun. Avoid installations requiring the air-oil mixture to move upward from the lubricator to the mender.
- ~ Install a separate lubricator for each air operated device to assure proper lubrication of each.



~ Lubricators are designed for operation under the air flow rate normal for the port size of each unit. Subnormal air flows may result from use of speed control valves in which case the lubricator size should be selected according to anticipated air flow rates rather than the port size of the devices to be served.

### **Operation**

~ The lubricator can be filled without shutting down the air line since removing the Fill Plug automatically shuts off the air supply to the bowl. Fill bowl to approximately 1/2 inch from rim with hydraulic or spindle oil with viscosity of 80 to 150 SSU at 100 degrees F. Compounded oils including automotive oils containing detergents or other additives such as solvents, soaps or graphite are not recommended.

~ Fill plug should be replaced and seated firmly to open the valve, pressurizing the bowl.

~ Operate the mender and observe the oil delivery rate in the oil feed indicator dome. (The rate of oil feed shown in the dome is 100% of the oil that is being injected into the air stream in mist form.) If the oil delivery rate appears too low or too great, adjustment can be made with the oil adjustment key.

~ If desired, the oil adjustment key, which controls the rate of oil delivery, may be removed by pulling it out from the head of the unit. This locks the oil adjustments to prevent tampering by unauthorized personnel. If readjustment is required, the key may be inserted into the lock to make the desired adjustments.

~ For extreme flow conditions, that is, low flow (5 CFM or under) or extremely high flows, to obtain the proper rate of oil delivery the internal vane may have to be adjusted.

To make this adjustment

~ Relieve line pressure to zero.

~ Remove dome by unscrewing dome clamp

~ With a 3/32 inch allen wrench, the vane may be rotated to the position "L" or "R". "L" signifies lean position for high flows. "R" signifies rich for low air flows. The unit has been preset at the factory with a vane position on "N" for normal operation which will provide proper lubrication for the majority of applications.

**Caution:** Do not attempt to disassemble unit while line is under pressure.



Precision Tufting Components, Inc. is the world's leading supplier of tufting loopers, tufting hooks, tufting blades, tufting needles, and tufting accessories. The success of our company is rooted in the industry experience of our founder Gary Brock, as well as the 40 professionals who manufacture and distribute our products. Since opening our doors in 1995, Precision's aim has been to be a full service supplier to the carpet tufting industry. In keeping with this thought, we are proud to offer several product lines including Schmetz Needles, Qwik Switch Modules, new Carbide Insert Hook styles, Air Menders, and tufting services.

### **Colleague of Products**

Single Loopers, Single Hooks, Looper Modules, Hook Modules, LCL Hook Modules, RFM Modules, Single Needles, Needle Modules, Air Menders, Needle Plate Wires, Needle Plates, Tufting Blades, Punch Needles, etc.



P.O. Box 710  
170 Jackson Lake Rd.  
Chatsworth, GA 30705  
Phone: 706.695.6593 Fax: 706.695.6594  
[www.ptuft.com](http://www.ptuft.com)